

WIRING SCHEMATIC

Motor Type: COLOR CODED-56

Control Type: AMS REVERSING SWITCH

Power Supply: 115V AC

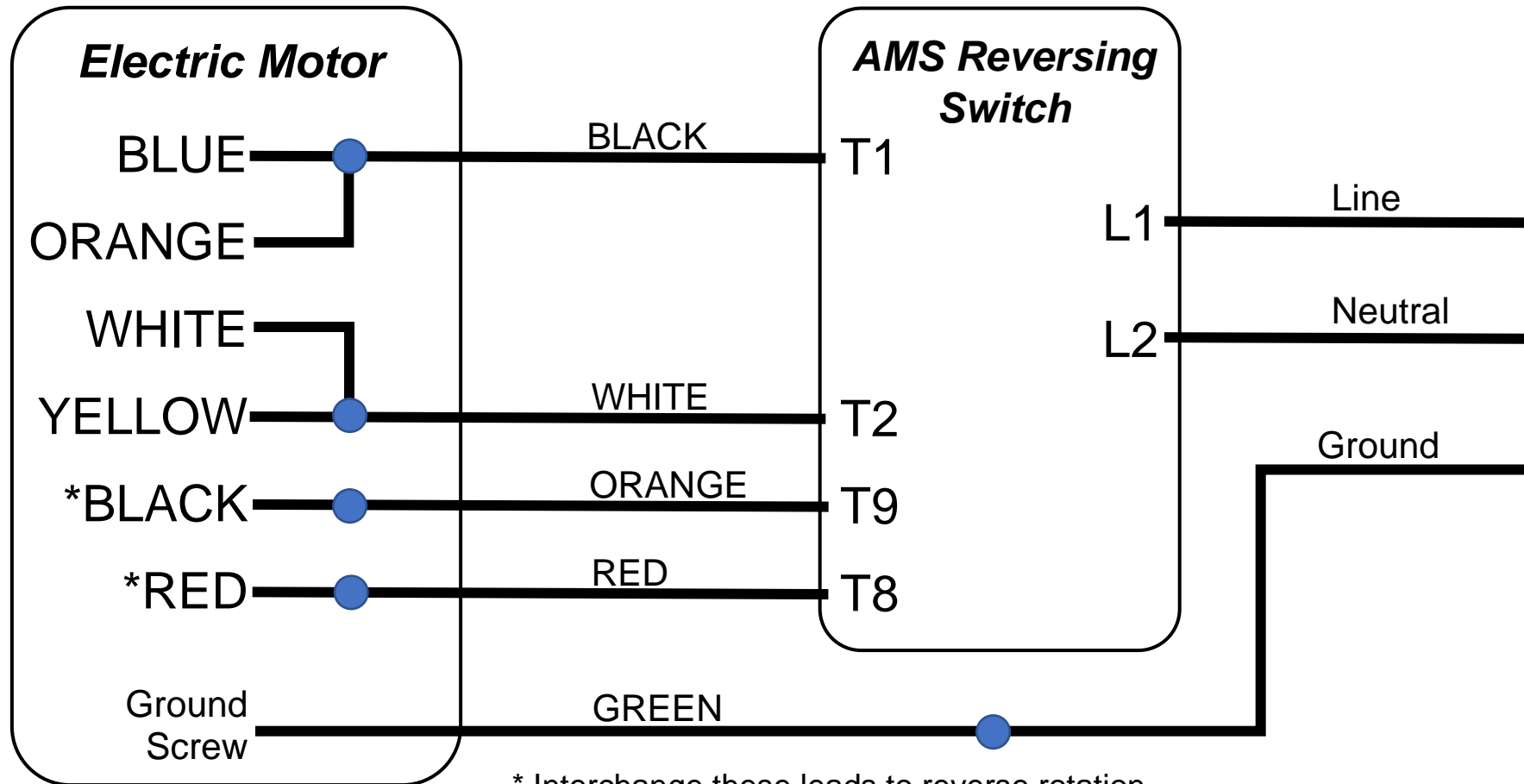

* Interchange these leads to reverse rotation