

ShorePort PWC Lift

Instructions

1022950 - 58" x 138" Tan ShorePort

1029301 - 58" x 138" Gray ShorePort

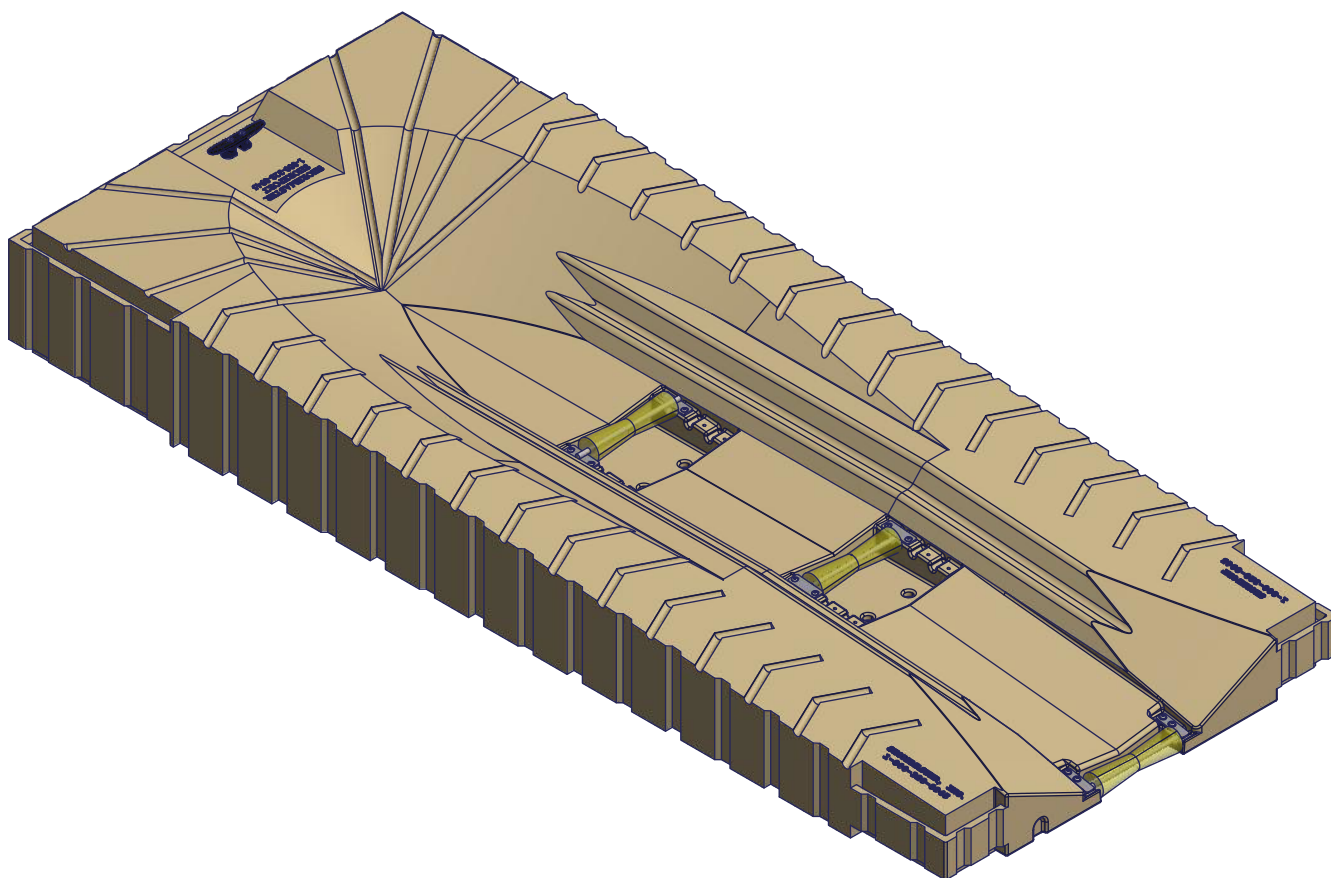

⚠ WARNING - PUT SAFETY FIRST

1. To avoid the risk of personal injury or death, study and fully understand the proper installation and operating procedures and safety precautions outlined in this owner's manual.
2. NOT COMPLYING WITH THE PROCEDURES AND PRECAUTIONS OUTLINED IN THIS MANUAL MAY RESULT IN PERSONAL INJURY OR DEATH AND WILL INVALIDATE THE WARRANTY.
3. Use caution when handling gasoline; plastic creates static electricity and may ignite flammable gases or liquids resulting in burns.
4. Never jump or dive into the water before the entire subsurface area has been checked for depth. Not doing so may result in personal injury or death.
5. Do not run on the ShorePort; the ShorePort has uneven surfaces and may be slippery when wet causing a falling injury.
6. Check bolts periodically to ensure hardware and connectors remain securely fastened.
7. If you have any questions about assembly, installation, use or suitability of this product, contact an authorized dealer or ShoreMaster directly at 800-328-8945.

ShorePort Parts List Instructions

Parts List			
ITEM	QTY	PART NUMBER	DESCRIPTION
1	1	1001786	Keel Roller Rear Assembly
2	4	1002599	Washer Flat 3/8 SS
3	4	1001788	3/8 x 3/4 Button Head Socket Cap Screw
-	1	1006595	Keel Roller Assembly with Hardware
4	1	1001776	Front Keel Roller Assembly
5	1	-	Shoreport 58" x 138"
6	4	1000613	Washer Flat 3/8 x 1.25 x .125 Rubber
-	1	1003475	Keel Roller Spacer Kit
7	4	1000655	3/8 x 1-1/2 Button Head Cap Screw
8	2	1013375	Keel Roller Spacer Plate
9	6	1004236	Optional Float (adds 50lbs cap each)
10	2	1000505	3/8 x 2-1/4 Flat Head Machine Screw
11	1	1001089	8" Plastic Cleat

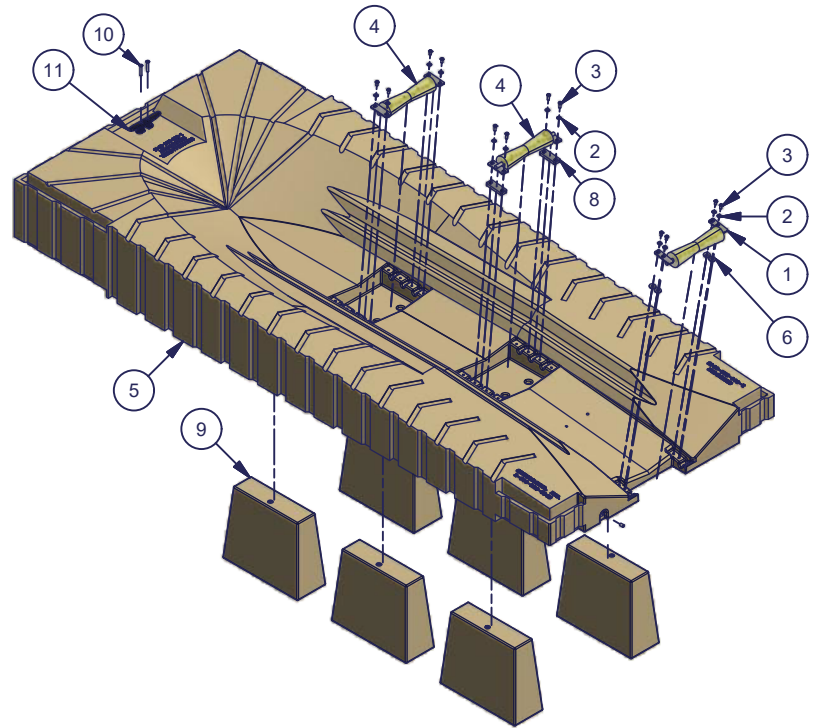

⚠ WARNING Not complying with the procedures and precautions outlined in this manual may result in personal injury or death and will invalidate the warranty.

Step 1. You may need to adjust rollers for best results. See next page for adjustment options.

Step 2. See Shoreport anchoring and attachment options page for available methods to anchor the Shoreport. (Pile guides, flexi-hinges, connectors, etc.)

Note: Add optional floats if necessary. (adds 50lbs each)

Note: The front of the ShorePort is 16" tall and will have a freeboard of about 14" without a PWC on it. The rear roller should rest about half way out of the water without a PWC on it. The freeboard can be increased by adding supplemental flotation (item 10).

ShorePort Keel Roller Adjustment Instructions

The rollers on the Shoreport have multiple adjustment locations in order to adjust the Shoreport to your personal water craft.

The front and middle rollers can be placed in three different slots and can also be flipped with axle above or below the plates. The rear roller can also be flipped but has only one location.

To adjust, use a 7/32" hex key to remove the four 3/8 button head bolts holding the roller in, move to desired position, and put the bolts back in to secure in place.

For PWC's that are difficult to unload we recommend having the front roller in the most forward position with the axle flipped above the plates (Position B) so it is the highest it can be and the middle roller in the most forward position with the axle facing down into the slots of the Shoreport (Position C).

With the many different designs of PWC's available you will need to adjust the rollers to fit your specific watercraft. As a general guideline, raising the front and middle rollers makes it easier to unload the PWC. However if the rollers are too high the PWC may not stay on the Shoreport and the rollers may need to be lowered. If the rollers do not provide enough height in the forward position with the axle up, there is a spacer kit available to raise the roller another 1/2 inch, part number 1003475 as shown in Position A.



A

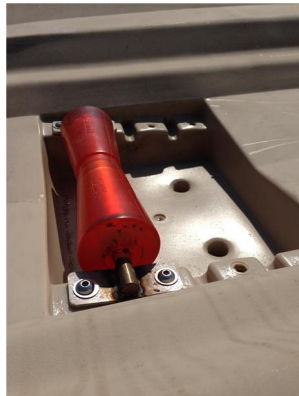

B



C



D



E



- A - Highest Position with Spacer Kit
- B - Highest Position no Spacer Kit Axle Up
- C - Roller in Forward (High) Position
- D - Roller in Middle Position
- E - Roller in Rear (Low) Position

The front and middle rollers can be used in all of the above positions. Positions D and E can also be used with the axle up. The axle needs to be up in order to use the spacer kit. The spacer kit can be used in any of the three slots.

To the left, recommended roller position for PWC's that are difficult to remove from the Shoreport. Front roller in position B, middle roller in position C.

How to Grease Rollers

If your keel rollers are hard to turn, you can add grease to them by using a grease gun with a snap in needle (the needle can be purchased from ShoreMaster with part number **1017538** or through a parts store). To add grease to the keel roller you will have to make sure your ShorePort came with the keel rollers that have a small hole drilled into the middle of the roller. If you have the hole, insert the needle on the grease gun into the hole and pump grease into the roller until grease comes out the end of the roller. If your keel rollers do not have the hole in the middle of them you can insert the needle between the roller and the shaft the roller rides on and pump grease into it until it comes out the other end. If the roller is still hard to turn the keel roller is probably bent and will have to be replaced.

Note: Use marine grade grease.

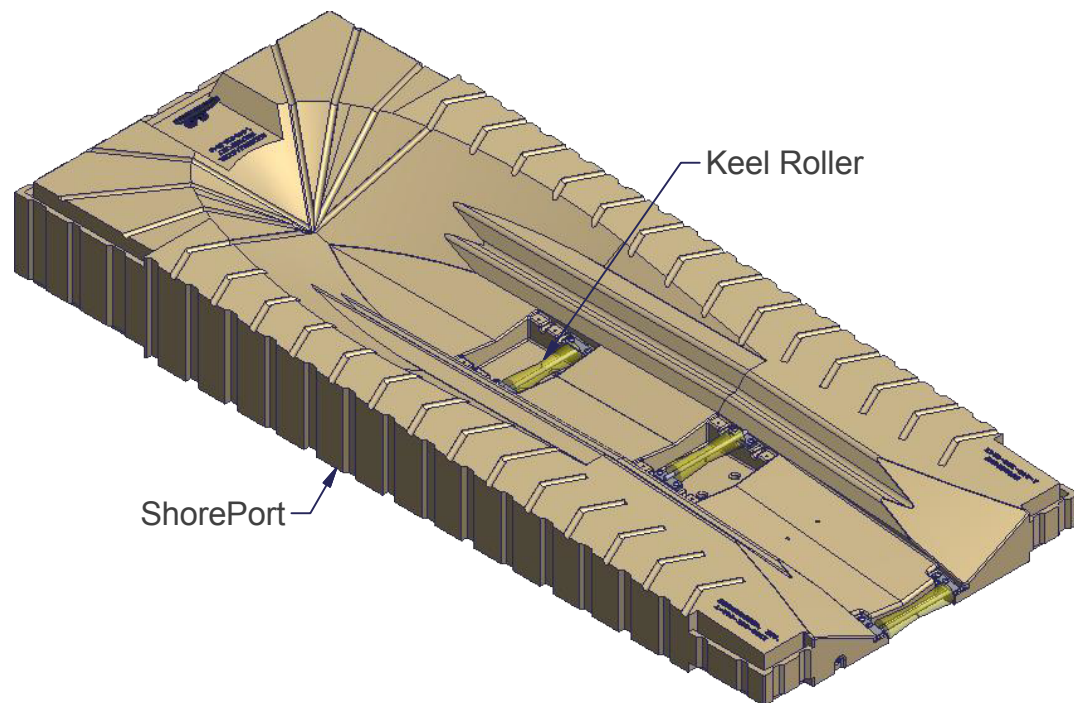
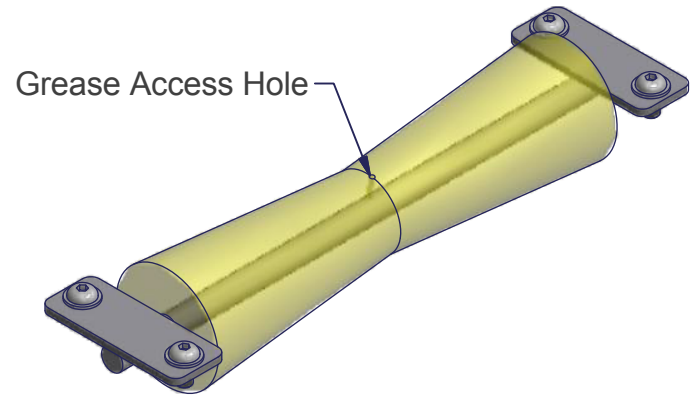

ShorePort Anchoring and Attachment Options

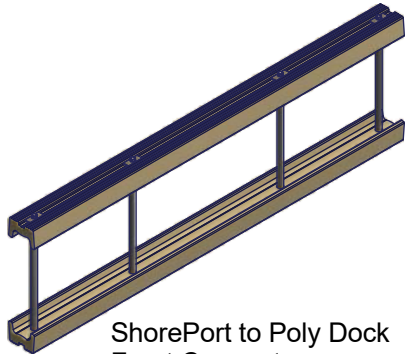

ShorePort to Poly Dock
Front Connector
P/N: 1007011 - Tan
1029365 - Gray

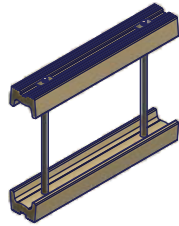

ShorePort to ShorePort
Side Front Connector
P/N: 1006631 - Tan
1029360 - Gray

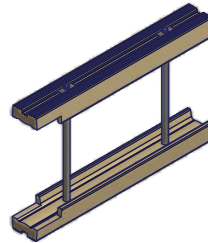

ShorePort to ShorePort
Notched Side Front Connector
P/N: 1003472 - Tan
1029359 - Gray

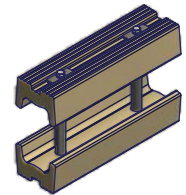

ShorePort to ShorePort
Side Rear Connector
P/N: 1007016 - Tan
1029358 - Gray

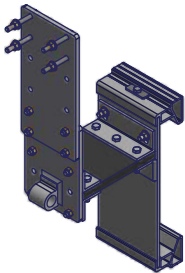

Single Hinge Assembly
ShorePort to Floating Dock
(In calm water).
P/N: 1007015 (Pair)

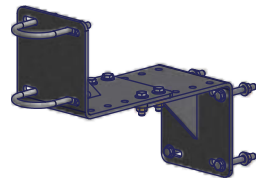

Stand-off Bracket
Secures Pipe to Dock
P/N: 1006715 (Pair)

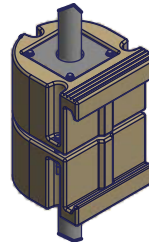

Small Pipe Bracket
(works best on side of
ShorePort)
P/N: 1022953 - Tan
1029312 - Gray

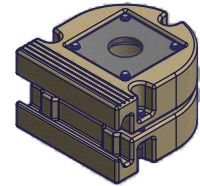

ShorePort Rear Pipe Bracket
(works only on side of
ShorePort)
P/N: 1022951 - Tan
1029314 - Gray

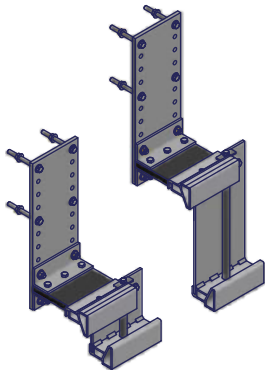

Side Mount Flexi-Hinge
Assembly ShorePort to
Floating Dock
P/N: 1013365

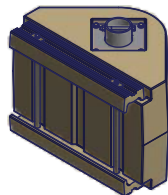

Heavy Duty Pipe
Bracket with Chain
Guide
P/N: 1023737 - Tan
1029304 - Gray

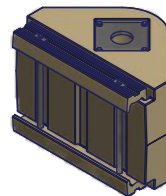

Heavy Duty Pipe
Bracket with
connector
P/N: 1022952 - Tan
1029310 - Gray

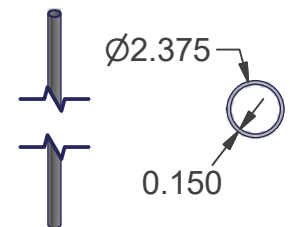

2" Schedule 40 Pipe (2-3/8" O.D.)
3' Pipe P/N:1007729
5'-3" Pipe P/N:1007732
7' Pipe P/N:1007736
10'-6" Pipe P/N:1007737
21' Pipe P/N:1002676

ShorePort to Poly Dock

The diagram below shows a typical ShorePort to poly dock installation. Before attaching ShorePorts to dock make sure dock is anchored properly. Consult with your local dealer for anchoring requirements. If needed you can attach ShorePorts rear pipe brackets to the back side of the ShorePorts. Remove the bottom wear plate so the pile guide does not bind up on the pipe.

Note: Refer to Poly Dock installation instructions for connector instructions.

Parts List		
ITEM	QTY	DESCRIPTION
1	2	4' x 10' Floating Poly Dock
2	2	ShorePort Front Connector
3	1	4' Poly Dock End Connector
4	1	Shoreport 1' Side Rear Connector
5	2	Shoreport
6	1	2' Notched Connector
7	2	Shoreport Rear Pipe Bracket with Hardware

Failure to follow instructions may result in personal injury and may invalidate the applicable warranty.

Step 1. Attach ShorePorts together using 2' Notched Connector and ShorePort 1' Side Rear Connector.

Step 2. Attach ShorePort to Poly Dock using ShorePort front connectors.

Step 3. Slide 2" schedule 40 pipe into pipe brackets and drive into ground using post pounder.

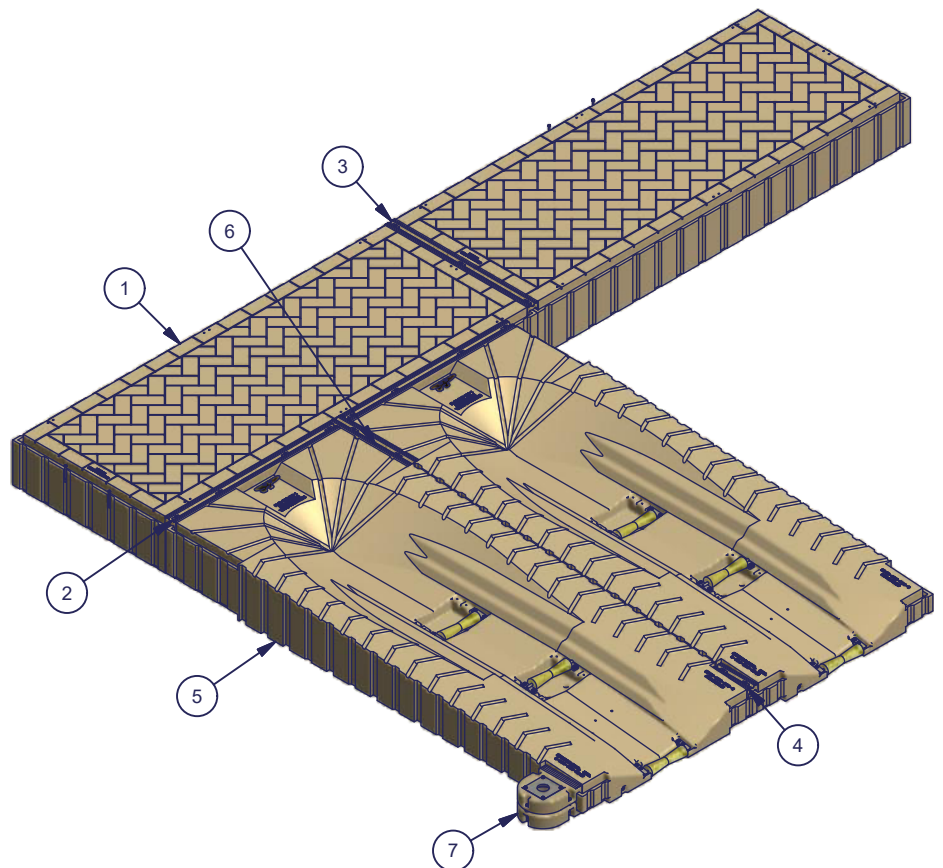

ShorePort Side Mount Flexi-Hinge

Instructions

Part #: 1013365

Failure to follow instructions may result in personal injury and may invalidate the applicable warranty.

Note: Refer to exploded parts drawing on following page for details on flexi hinge assembly.

Step 1. Attach flexi hinge assembly extension plate to floating dock. Plates will have to be spaced about 116-1/4" between plates so they will line up to corresponding plates on the ShorePort. Attach brackets to ShorePort and measure between to verify spacing.

Step 2. Assemble flexi hinge assembly. Slide connecting rod through hole in bottom of flexi hinge assembly weldment and attach using oval screw (you will have to drill a pilot hole for screw). Next insert 5/16 x 4-1/2" hex bolt through lock washer, rectangular washer and insert through hole in accessory top connector and thread into connector rod just enough to hold it together. Attach rubber plate to flexi hinge assembly weldment using one flexi hinge assembly angle, three 3/8 x 2 hex bolts and 3/8 nylock nuts. Attach two other flexi hinge assembly angles to other end of rubber plate using three 3/8 x 2 hex bolts and 3/8 nylock nuts (make sure to bolt through the holes not the slots).

Step 3. Attach previously assembled portion of flexi hinge assembly to front of ShorePort so the connecting rod will end up centered in the second vertical groove on the front of the ShorePort and attach the rear side flexi-hinge to the rear side of the ShorePort so its connector rod is centered in second groove from the back of the ShorePort. Leave connecting rod bolt loose.

Step 4. With no weight on the ShorePort float ShorePort next to floating dock and attach flexi hinge assembly extension plate to flexi hinge assembly angles using four 3/8 x 1-1/4 hex bolts, flat washers and nylock nuts. Make sure ShorePort is floating level in the water and rubber plate is level before attaching. After attached tighten all hardware. Torque 5/16" x 4-1/2" connector rod bolts to 20 ft/lbs. **DO NOT OVERTIGHTEN AND DO NOT USE A HIGH SPEED DRILL.**

Note: If you are in an area with heavy boat traffic or waves greater than 1'-6" use stand-off brackets and pipe brackets instead of the flexi hinge assembly. Side mount flexi-hinge assembly should be used to attach only one ShorePort parallel to dock. If multiple ShorePorts are to be attached side by side pipe brackets should be used instead of side mount flexi-hinge.

Kit includes front and back brackets to attach side of ShorePort to floating dock.

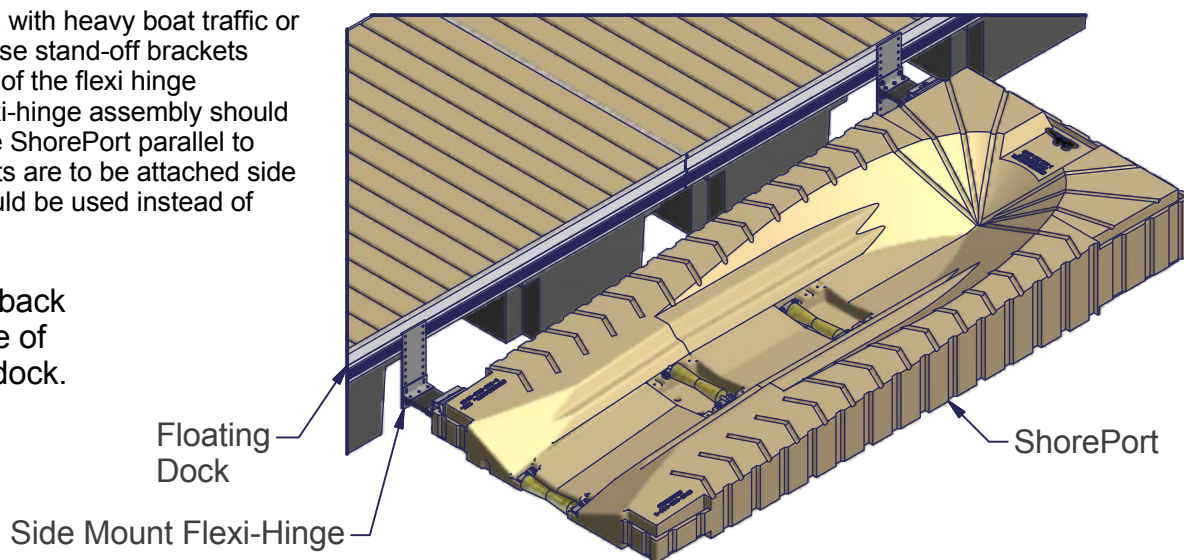

ShorePort Parallel to Poly Dock

Parts List		
ITEM	QTY	DESCRIPTION
1	1	4' x 10' Floating Poly Dock
2	1	ShorePort
3	1	Large Pipe Bracket with Connector
4	1	Poly Pipe Bracket / ShorePort Side Connector
5	1	Shoreport Rear Pipe Bracket with Hardware
6	2	2" Schedule 40 Pipe

Failure to follow instructions may result in personal injury and may invalidate the applicable warranty.

Step 1. Attach ShorePort to Poly Dock using poly pipe bracket / ShorePort side connector.

Step 2. Attach poly pipe bracket to ShorePort.

Step 3. Slide 2" schedule 40 pipe into pipe brackets and drive into ground using post pounder.

Note: DO NOT attach ShorePort to Poly Dock using only poly pipe bracket / ShorePort side connector you must also use a pipe bracket on the outside of the ShorePort (as shown).

Note: See Connector Instructions for directions on how to assemble ShorePort connectors.

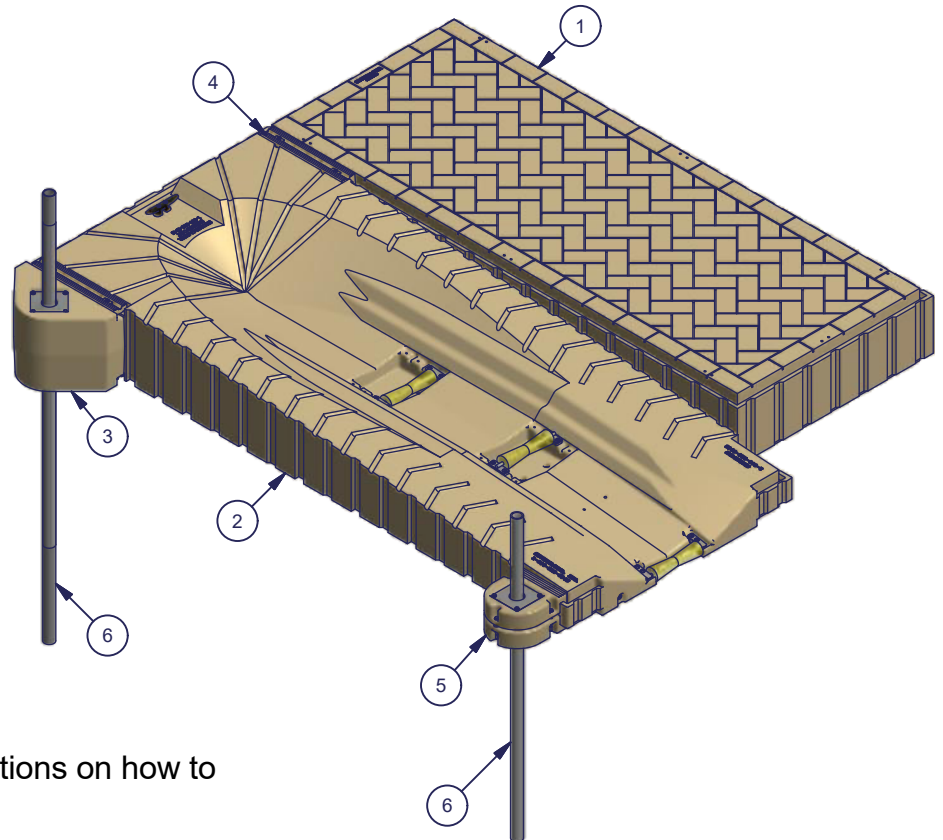

ShorePort to Standing Dock or Sea Wall

Parts List		
ITEM	QTY	DESCRIPTION
1	1	ShorePort
2	2	2" schedule 40 PIPE
3	1	Standing Dock or Sea Wall
4	1	Universal Stand-off Plate Assembly (Pair)
5	2	Large Pipe Bracket with Connector

Failure to follow instructions may result in personal injury and may invalidate the applicable warranty.

Step 1. Attach pipe brackets to ShorePort (as shown) depending on how you want your ShorePort fastened to your dock or sea wall.

Step 2. Assemble and attach stand-off brackets to dock or sea wall. If ShorePort is perpendicular to dock (as shown in top picture) assemble stand-off brackets using last four holes in plates so brackets will hold pipes further away from dock. Measure from center of pipe bracket to the center of the other pipe bracket and space stand-off brackets apart center to center to that distance. If ShorePort is parallel to dock (as shown in middle picture) assemble stand-off brackets so they are as short as possible to keep ShorePort closer to the dock. Measure from center of pipe bracket to the center of the other pipe bracket and space stand-off brackets apart center to center to that distance.

Step 3. Float ShorePort up next to dock and slide pipe down through pipe brackets. Align pipe up with stand-off brackets and pound pipe into lake bottom using a sledge hammer or post pounder.

Step 4. Attach pipe to stand-off brackets using provided U-bolts.

Note: If your dock is too close to the water bolt the stand-off brackets to a treated 2" x 8" and bolt the 2" x 8" to the dock (as shown in Detail A).

Parts List		
ITEM	QTY	DESCRIPTION
1	1	ShorePort
2	1	Universal Stand-off Plate Assembly (Pair)
3	2	2" Schedule 40 Pipe
4	1	Shoreport Rear Pipe Bracket with Hardware
5	1	Medium Pipe Bracket with Hardware
6	1	Standing Dock or Sea Wall

